



NEW
Insulated external doors with thermal break



Doors for Your Home

Quality from the basement to the roof







KSI Thermo Security Door // NEW	4
KSI Security Door	6
MZ Thermo Multi-Purpose Door // NEW	8
MZ Multi-Purpose Door	10
H8-5 Fire-Rated Door	12
H3D Multi-Purpose Door	14
WAT Fire-Rated Security Door // NEW	16
ZK Internal Door	18
Colours and Decor Surfaces	21
Steel Frames	22
Size Range	24
Programme overview	26

High-quality steel doors for new construction and modernisation

Hörmann has the right door for all areas in your home: for making the entrance to the basement secure, for workshops or hobby rooms, a child's or teenager's bedroom, a converted loft or as a door connecting the garage with the rest of the house.

The classification of the individual doors shows you at a glance which functions the respective door fulfils and to what extent – from highly suitable (★★★★★ / 5 stars) to unsuitable (no stars).

*Up to 30% better thermal insulation in comparison with a conventional multi-purpose door / security door

Products on title page (from left): H8-5 fire-rated door in Grey white RAL 9002, KSI Thermo external security door in Anthracite RAL 7016, ZK internal door in Anthracite RAL 7016.

Figure on left: H3D multi-function door, painted on site in Anthracite RAL 7016

The colours and surface finishes shown are subject to the limitations of the printing process and cannot be regarded as binding.

All rights reserved. No part may be reproduced without our prior permission. Subject to changes.

KSI Thermo Security Door

Brand quality with two advantages:

High security and the best thermal insulation

NEW



The new KSI Thermo security door offers many advantages: thanks to a door leaf with thermal break, it offers the best thermal insulation and also comes with break-in-resistant WK 2 security equipment. We recommend using this quality door as an external door for basements, outbuildings and garages.



Product characteristics

Break-in resistance

★★★★★

Thermal insulation

★★★★★

Acoustic insulation

★★

Fire-retarding

Stress

★★★★★

Deformation resistance

★★★★★

External door for

- Basements
- Heated outbuildings
- Garages with direct access to the home

Ready-to-fit door set

Door leaf and frame **with thermal break**, galvanized and painted in Traffic white (similar to RAL 9016).

Single-leaf

Break-in-resistant WK 2

acc. to DIN V ENV 1627 on opposite hinge side.

Thermally insulated

$U_D = 1.2 \text{ W/m}^2\text{K}$



Colours and Decor Surfaces
Size Range

Page 21
Page 24

Thermal insulation like in an entrance door

These days, saving energy is important throughout the entire home. The KSI Thermo security door provides excellent thermal insulation as the door leaf filled with PU rigid foam, frame and threshold all come with a thermal break. The door also features double seals on all four sides. With all of this, the KSI Thermo has a thermal insulation value usually only found in entrance doors.

Security as standard

Basement and outbuilding doors are often weak spots when it comes to security. In this respect, the KSI Thermo offers the best equipment as well: 2 conical swing bolts plus 2 additional security bolts and 1 lock bolt engage in the frame's lock plate and firmly pull the door shut. 3 further security bolts and 3 additional hinges make it practically impossible to force the door open.



Best thermal insulation thanks to door leaf, frame and threshold with thermal break

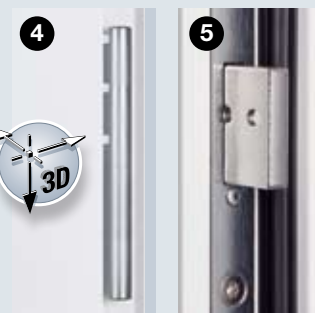

Three-way adjustable hinges for easy door function

Lock bolt for standard security



Swing bolt with security bolt

Security bolts on the hinge side

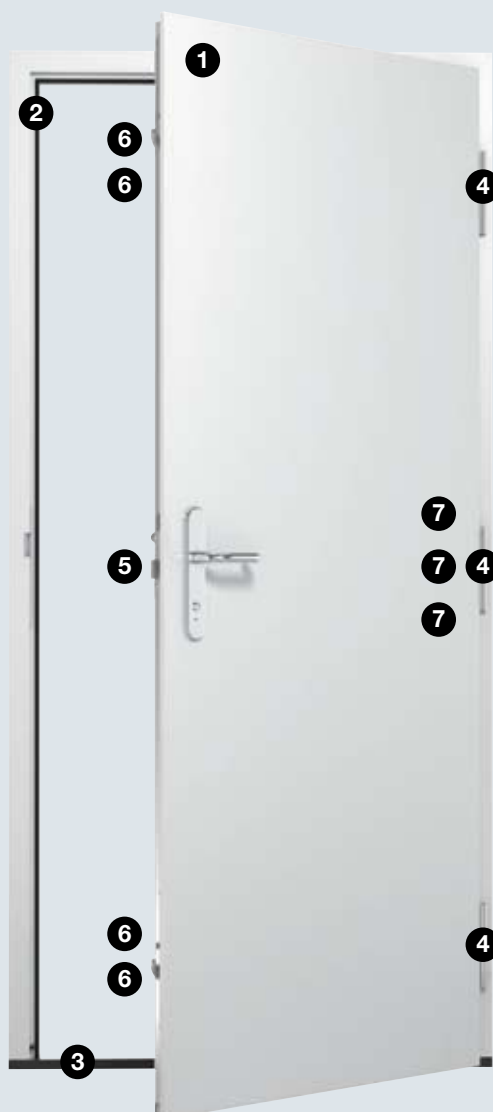

KSI Security Door

Additional security with the proven classic



Basement entrances, outbuildings and garages are often equipped with old doors that can be forced open in seconds. Always remember: if the basement door is open, the whole house is accessible. This is why we recommend the KSI security door with standard security equipment for these areas.



Product characteristics

Break-in resistance

★ ★ ★ ★ ★

Thermal insulation

★ ★ ★

Acoustic insulation

★ ★

Fire-retarding

Stress

★ ★ ★ ★ ★

Deformation resistance

★ ★ ★ ★ ★

External door for

- Basements
- Unheated outbuildings
- Free-standing garages

Ready-to-fit door set

Door leaf and frame, galvanized and with powder-coated primer in Traffic white (similar to RAL 9016).

Single-leaf

Break-in-resistant WK 2

acc. to DIN V EN V 1627 on hinge side and opposite hinge side.

Thermally insulated

$U_D = 1.7 \text{ W/m}^2\text{K}$

Acoustic-rated

with retractable bottom seal
Rw approx. 32 dB

Climatic class III

acc. to RAL-RG 426

Duty category S

acc. to RAL-RG 426



Colours and
Decor Surfaces
Size Range

Page 21
Page 24

Stable door leaf

The KSI features a double-skinned, 40-mm-thick **door leaf** with 3-sided thick rebate and sheet steel on both sides (0.8 mm). The stability of the door leaf is a result of the all-round reinforcement frame and the mineral wool insert which is glued over the entire surface. A 3-sided EPDM seal and double lip seal (incl. aluminium semicircular threshold at the bottom) seal the door reliably. This means you can always rely on the door in terms of function and tightness. Hörmann offers this door as a complete set with frame.

High security

The standard security of the KSI lets you and your family sleep peacefully, as it comes with pull-off protection and a drill-resistant security lever / knob handle set. The solid steel bolts on the hinge side make it almost impossible to force the door open. The KSI has been tested in accordance with European standard DIN V ENV 1627 on the hinge and opposite hinge side and has resistance class 2.



1.5-mm-thick corner frame with all-round seal

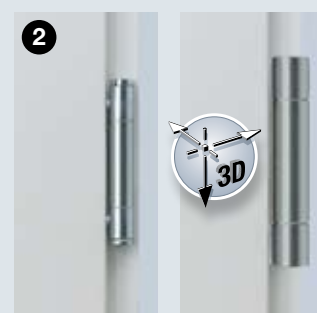

3-piece hinge (standard)

Three-way adjustable VX hinge (on request)

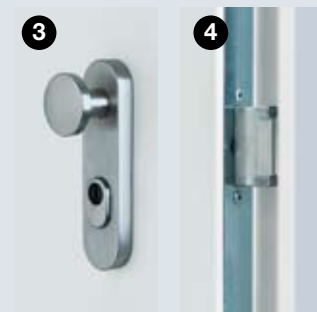

Security lever / knob handle set with drilling and pull-off protection

Lock bolt for standard security



Solid steel security bolts on the hinge side



MZ Thermo Multi-Purpose Door

External door with thermal break
and the best thermal insulation values

NEW



The new MZ Thermo multi-purpose door is more than just extremely robust. Thanks to a thermal break, it features up to 30% better thermal insulation than a conventional multi-purpose door. It is available with or without glazing and in numerous colours and decor surfaces.



Product characteristics

Break-in resistance

★ ★

Thermal insulation

★ ★ ★ ★ ★

Acoustic insulation

★ ★

Fire-retarding

Stress

★ ★ ★ ★ ★

Deformation resistance

★ ★ ★ ★ ★

External door for

- Basements
- Heated outbuildings
- Garages with direct access to the home
- Workshops and hobby rooms

Ready-to-fit door set

Door leaf and frame **with thermal break**, galvanized and painted in Traffic white (similar to RAL 9016).

Single-leaf

Thermally insulated

TPS 011: $U_D = 1.2 \text{ W/m}^2\text{K}$

TPS 021: $U_D = 1.4 \text{ W/m}^2\text{K}$

TPS 021 glazing

Double insulated glazing (24 mm) with a U-value of up to $1.3 \text{ W/m}^2\text{K}$. With round-style plastic glazing frame.

High thermal insulation

The new MZ Thermo multi-purpose door will help you reduce heating losses permanently. The door leaf with PU rigid foam infill, frame and threshold all come with a thermal break. This and the all-round double seals on all four sides make sure the door is perfectly sealed and improves thermal insulation by up to 30% compared to a conventional multi-purpose door.

Stability and function

The MZ Thermo is exceptionally stable and robust thanks to a 46-mm-thick, fully filled door leaf. The door can be optimally adjusted using the three-way adjustable hinges.

With or without glazing

On request, the MZ Thermo also comes with glazing to let daylight into your workshop or hobby room. The glazed versions also offer excellent thermal insulation thanks to double insulated glass.



Best thermal insulation thanks to door leaf, frame and threshold with thermal break



TPS 011

TPS 021

You may choose from 2 styles: a solid door leaf or with glazing.



**Colours and
Decor Surfaces**
Size Range

Page 21

Page 24

MZ Multi-Purpose Door

Stable and inexpensive internal and external door



Proven for over four decades, this multi-purpose door is stable, durable and weather-resistant, making it ideal for inside and outside. The MZ comes in a single-leaf or double-leaf design and is available with glazing on request.

Product characteristics

Break-in resistance

★ ★

Thermal insulation

★ ★ ★

Acoustic insulation

★ ★ ★

Fire-retarding

Stress

★ ★ ★ ★ ★

Deformation resistance

★ ★ ★ ★ ★

Internal and external door for

- Unheated outbuildings
- Utility sheds
- Storage rooms

Ready-to-fit door set

Door leaf and frame, galvanized and with powder-coated primer in Grey white (similar to RAL 9002).

Single- or double-leaf

Thermally insulated

$U_D = 1.7 \text{ W/m}^2\text{K}^*$

Acoustic-rated

Rw approx. 39 dB*

Possible additional functions:

T30 fire-retarding*

As an H8-5 fire-rated door up to door size 1000 × 2125 mm (see page 12)

* For doors without glazing and with corner frame

Size Range

Page 24

Stability for you

This ready-to-fit door set is especially robust thanks to a double-skinned, 45-mm-thick door leaf rebated on both sides, a sheet thickness of 0.9 mm, a mineral wool infill and steel reinforcement. The door provides a very high level of security with 2 solid steel security bolts. A 2-mm-thick corner frame with all-round EPDM seal keeps the door shut tight and has a bottom threshold rail that can be easily removed. The door is also available with a block frame and a 3-sided EPDM seal on request.

More light thanks to glazing

Hörmann also offers its MZ multi-purpose door with glazing. Due to security reasons, this glazing is kept very narrow, but it still lets you benefit from daylight inside. 7-mm wired glass is provided as standard, but 20 mm insulated wired glass with a view of 230 × 1360 mm is also possible. The natural-finish aluminium glazing frame is fastened on the opposite hinge side with glazing beads (optionally on the hinge side).



2-mm-thick corner frame with all-round seal



With glazing on request



H8-5 Fire-Rated Door

The best-selling boiler room door in Germany



For decades, the H8-5 fire-rated door has been providing optimum safety for boiler rooms and rooms with oil tanks. This door is the best example of how you can profit from Hörmann's expertise in fire protection.



Product characteristics

Break-in resistance

★ ★

Thermal insulation

★ ★

Acoustic insulation

★ ★ ★

Fire-retarding

★ ★ ★ ★ ★

Stress

★ ★ ★ ★ ★

Deformation resistance

★ ★ ★ ★ ★

Internal door for

- Boiler rooms
- Rooms with oil tanks

Ready-to-fit door set

Door leaf and frame, galvanized and with powder-coated primer in Grey white (similar to RAL 9002).

Single-leaf

Dual handed

T30 fire-retarding

acc. to DIN EN 1634

Thermal insulation

acc. to EN ISO 12567-1
 $U_D = 1.7 \text{ W/m}^2\text{K}^*$

Acoustic-rated

acc. to DIN 52210
 Rw approx. 39 dB*

Possible additional functions:

Smoke-tight

acc. to DIN 18095
 with overhead door closer,
 smoke-tight seal and threshold**.

* With all-round seal
 ** Not suitable for escape
 and rescue routes

Stable door leaf

The double-skinned, 45-mm-thick door leaf is rebated on two sides. With a sheet thickness of 0.9 mm it is highly stable and is equipped with a fire-retarding mineral wool infill, steel reinforcement and 2 steel security bolts. The lock and lever handle set may be used with profile cylinders and deadlock keys. One deadlock key is provided.

Integrated fire protection

On both the door and fire hatch the fire-proof material is not exposed but is concealed on the front side across the full width and flush-fitting.

Sealed all-round

The 2-mm-thick corner frame with all-round seal reliably seals the H8-5 fire-rated door. The bottom threshold rail is easy to remove if fitted with a continuous floor.

Also as a smoke-tight door

On request, the H8-5 can be equipped with optional extras such as an overhead door closer, smoke-tight seal and threshold** to make it a smoke-tight door.



2-mm-thick corner frame with all-round seal



The model H8-5 fire hatch is recommended for rooms with oil tanks



H3D Multi-Function Door

The functional door for the passage from the garage into the house



Due to fire hazards in garages, a fire-rated door law between the house and garage is required by law. The H3D multi-purpose door is the best choice for this sensitive area. On request, this door can also act as a seal against smoke and engine noise.



Product characteristics

Internal door

for the passage
from the garage
into the house

Ready-to-fit door set

Door leaf and frame,
galvanized and with
powder-coated
primer in Grey white
(similar to RAL 9002).

Single- or double-leaf

T30 fire-retarding
acc. to DIN EN 4102

Thermally insulated

$U_D = 1.9 \text{ W/m}^2\text{K}$

Possible additional functions / optional extras:

Smoke-tight

acc. to DIN 18095

With the following optional extras:

- Retractable bottom seal or aluminium bottom profile with seal
- Overhead door closer and profile cylinder

Acoustic-rated*

acc. to DIN EN ISO 717.1

With the following optional extras:

- Bottom seal Rw 37 dB
- Aluminium bottom profile Rw 41 dB
- Threshold rail Rw 44 dB

Break-in-resistant WK 2**

acc. to DIN ENV 162

With the following optional extras:

- 2 additional security bolts
- Drill-proof locking cylinder acc. to DIN 18252, P-3-BS
- Aluminium security fitting in acc. with DIN 18257, class ES1

Glazings

- Clear F30 fire-proof glass
- Please note: glazed doors require an overhead door closer.

* The acoustic values apply to solid doors without glazing and are not applicable to doors fitted into gas concrete.

** The resistance class WK 2 applies to doors without glazing and is not applicable to doors fitted into partition walls.

Sturdy door leaf

The double-skinned, 45-mm-thick door leaf comes with a mineral wool infill, steel reinforcement and steel security bolts. The 2-mm-thick corner frame is equipped with a 3-sided EPDM seal and is easy to fit using grouting lugs.

With optional glazing

On request, the H3D multi-function door is available with clear fire-proof glass for more light. These doors are equipped with an additional overhead door closer.

Optional extras for further functions

You can increase the acoustic insulation and break-in-resistance of the H3D with various optional extras or even make it a smoke-tight door.

Four types of clear F30 fire-proof glass are available for the H3D

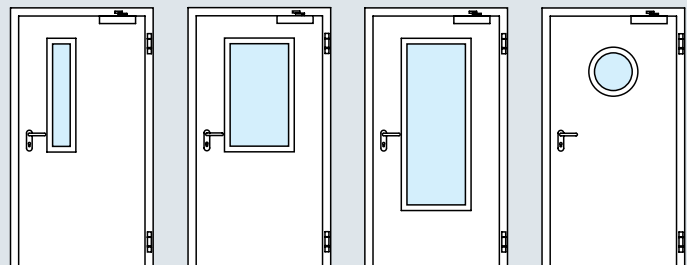

Glazing
View 1

Glazing
view 2

Glazing
View 3

Round glazing
Ø 300, 400,
500 mm



WAT Fire-Rated Security Doors

As a passage from the garage into the home

NEW



With standard fire-protection and security functions, the new WAT is the right choice for the passage from the garage into the hallway of your home. With a thick rebate leaf design and numerous colour and surface options, the door blends in perfectly with the other internal doors in your home.



Product characteristics

Break-in resistance

★ ★ ★ ★ ★

Thermal insulation

★ ★

Acoustic insulation

★ ★

Fire-retarding

★ ★ ★ ★ ★

Stress

★ ★ ★ ★ ★

Deformation resistance

★ ★ ★ ★ ★

Internal door

for the passage from the garage into the home

Ready-to-fit door set

Door leaf and frame, galvanized and painted in Traffic white (similar to RAL 9016).

Single-leaf

T30 fire-retarding

acc. to DIN EN 1634

Break-in-resistant WK 2**

acc. to DIN EN V 1627

Thermally insulated

$U_D = 2.3 \text{ W/m}^2\text{K}$

Acoustic-rated

acc. to DIN 52210

Rw approx. 30 dB



Colours and
Decor Surfaces
Size Range

Page 21

Page 24

Stable and functional

The WAT features a double-skinned door leaf with a thick rebate design, an insert which is glued over the entire surface and sheet steel on both sides, making it especially stable. Door function and tightness are always ensured thanks to the three-way adjustable hinges and double all-round seals.

Standard security and fire protection

The WAT provides a high level of security through its multiple-point locking which features a security lever / knob handle set with drilling and pull-off protection and 3 steel bolts to prevent forced opening. This and the fact that it can withstand a fire for at least 30 minutes make the WAT the right choice if fire protection and security are equally important to you.

Various surfaces

Hörmann offers the WAT in various surfaces, like, for example, the Decograin version. The door blends in perfectly with the other doors in your home thanks to this natural timber look.



Stable door leaf in a thick rebate design

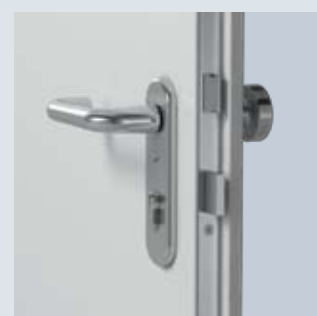

Security lever / knob handle set with drilling and pull-off protection



Three-way adjustable guide rollers for easy door function

A solid steel bolt on the hinge side prevents forced opening



ZK Internal Door

The durable and inexpensive door for individual designs



Over many years, Hörmann's ZK doors have proven themselves as robust doors for everywhere from the basement to the roof. ZK doors do not warp and come with a high-quality surface that is durable, resistant to stains and easy to clean. Reliable quality at a low price.

Product characteristics

Break-in resistance

Thermal insulation

★ ★

Acoustic insulation

Fire-retarding

Stress

★ ★ ★ ★

Deformation resistance

★ ★ ★ ★ ★

Internal door for

- Basements
- Children's rooms
- Entrance to an unrenovated loft

Door leaf or single, ready-to-fit door set

Door leaf and frame, galvanized and painted in Traffic white (similar to RAL 9016).

Single- or double-leaf

Thermally insulated

$U_D = 2.1 \text{ W/m}^2\text{K}^*$

Acoustic-rated

Rw approx. 25 dB*

Climatic class III

acc. to RAL-RG 426

Duty category S

acc. to RAL-RG 426

* For doors without glazing and with corner frame

Optional extras Page 20



Colours and Decor Surfaces Page 21

Size Range Page 24

Stable door leaf

The double-skinned, 40-mm-thick door leaf with a thick rebate on 3 sides consists of galvanized sheet steel (0.6 mm) and a honeycomb insert glued over the entire surface, making it dimensionally stable and robust.

Fully equipped as standard

As standard, you will receive the ZK internal door with a fitted lock and bright galvanized hinge top parts V0020, firmly screwed into the reinforced sections, but without a lever handle set.

As just a door leaf or ready-to-fit with a frame

The ZK internal door is supplied as just a door leaf or as a ready-to-fit door set, i.e. complete with lever handle set and special corner frame in Traffic white.

Smooth, quiet closing

The door has a mortice lever/knob handle set in acc. with DIN 18251 class 3 and is prepared for profile cylinders (backset 55 mm). The door closes easily and quietly since it is equipped as standard with a plastic catch and steel bolt, deadlock insert and key, also comes with a profile cylinder on request.

Flexible fitting

Thanks to the height adjustment and individual surface design, ZK doors are also ideal for modernising any room from the basement to the roof. They can be flexibly used in existing standard frames and all Hörmann steel frames (prepared for series V 8000 hinges).

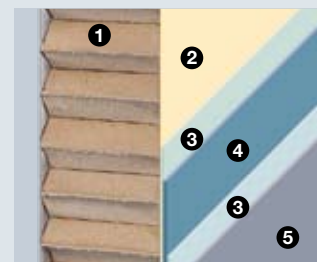

- 1 Honeycomb insert
- 2 Bonding agent
- 3 Zinc coating
- 4 Steel
- 5 Powder-coating / foil-coating

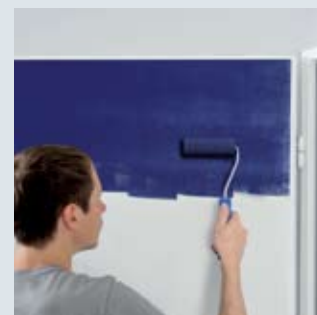

You can individually design your door's smooth, silk matt surface.



The door leaf can be shortened at the bottom. With a height adjustment of up to 20 mm, this door is suitable for any modernisation project.



ZK Internal Door

Extra equipment for an individual design

Glazing shapes



Round glazing
 Ø 300 or 400 mm,
 frame aluminium
 anodised in natural
 finish (E6 / EV1),
 brushed stainless
 steel on request.



Glazing view 5
 Frame for galvanized
 door leaf: paintable
 aluminium



Glazing view 6
 Frame for powder-
 coated door leaf:
 Aluminium anodised
 in natural finish
 (E6 / EV1).



Glazing view 7
 Frame for foil-
 coated door leaf:
 stained timber,
 matching the
 door leaf.



Masterpoint



Mastercarré



Masterligne

The glazing in the door

All ZK doors are available with glazing
 in the structures shown, with light 7-mm
 wired ornamental glass, 6-mm single-pane
 or laminated safety glass

For on-site glazing, please note the pane
 thickness of 4 – 6 mm. Round glazing
 is only available from the factory.

Optional extras

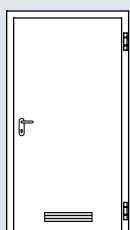

Plastic
 ventilation grille
 (455 x 90 mm)

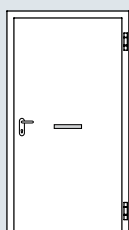

Letter drop flap

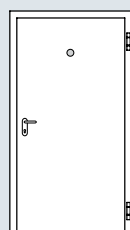

Wide-angle
 spyhole

Lever handle sets in various shapes and surfaces



Plastic in black, red,
 brown, white and yellow



Stainless steel



Aluminium

Colours and Decor Surfaces

Whatever you want!

Preferred colours*

Hörmann function doors come in 12 inexpensive preferred colours and all RAL colours. A high-quality powder-coated primer surface (painted with external doors) makes them especially weather-resistant and durable.

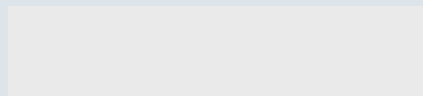

Traffic white RAL 9016

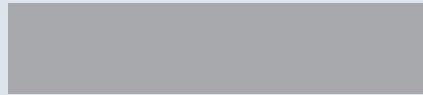

White aluminium RAL 9006

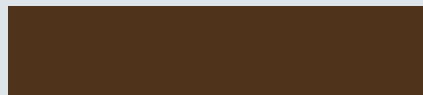

Terra brown RAL 8028

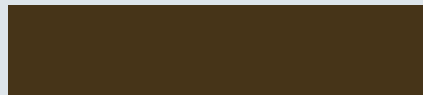

Sepia brown RAL 8014



Clay brown RAL 8003



Window grey RAL 7040

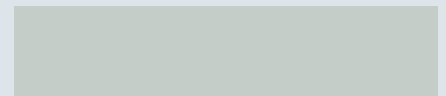

Light grey RAL 7035



Anthracite grey RAL 7016



Moss green RAL 6005



Pigeon blue RAL 5014



Ruby red RAL 3003

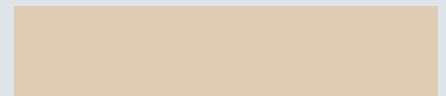

Light ivory RAL 1015

RAL to choose

The KSI security door and ZK internal door are available in all RAL colours on request.



Decor surfaces*

For a natural or exclusive door style, we offer high-quality decor surfaces in 5 true-to-original timber looks as well as the especially elegant Titanium Metallic surface finish.



Golden Oak



Dark Oak

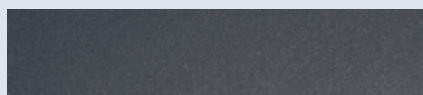

Titan Metallic (only MZ Thermo / KSI Thermo)

Only for internal doors

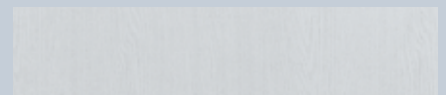

White Ash



Light Oak



Beech

* Except for MZ, H8-5, H3D doors

Steel Frames

Proven and inexpensive frames for standard steel / timber internal doors



Hörmann steel frames are especially robust and can withstand “accidents” with toy cars or run-ins with hard objects. The hot-galvanized, powder-coated primer surface can be painted individually, letting you match it perfectly to the look of the steel or timber doors used.

Product characteristics

Corner and profile frames

for 40-mm-thick rebated door leaves

Ready-to-fit standard frames

Galvanized and with powder-coated primer in Light grey (similar to RAL 7035).

Versions

- Ready-to-fit and welded
- To screw or clamp

Fitting in

- Brickwork
- Partition wall

Corner or profile frame

How do you want to use your internal door? This question must be answered before you select your frame.

If installed in brickwork, in the basement for example, an inexpensive corner frame is all you need. However, for the living areas we recommend a profile frame enveloping the wall. Partition wall frames are always designed as profile frames and are ideal for dry loft constructions.

Welded or to screw or clamp

All Hörmann standard frames for brickwork or partition walls are ready-to-fit and welded or to screw or clamp, come in a handy package that can be transported in a car and are already prepared for easy fitting by yourself.

Fully equipped

Each frame comes with everything you need: fixing material as well as markings for exact fitting and information on paint treatment. The standard grey hollow chamber sound-absorbing seal can be easily pulled through and ensures quiet and tight closing of the door. Also available in white, brown or black on request.

Variety is our strength

We have every frame you could possibly need. We offer door and window frames or passage frames between rooms. These frames are available with segmental arches or Norman arches or also in a combination with a side element and transom light. All are tailored to your wishes. Also available in a final coating in any RAL colour or an elegant stainless steel version. We would be pleased to advise you.



Corner and profile frames



Screw or clamp frame



Plug frames in handy packaging for super-easy fitting by yourself

Bottom image: sliding door frame for glass and timber pocket doors.



Size Range

Standard sizes	External doors				Internal doors				
	Security door		Multi-purpose door		Fire-rated door		Multi-function door	Fire-rated security door	Internal door
	KSI Thermo	KSI	MZ Thermo	MZ	H8-5 door	H8-5 hatch	H3D	WAT	ZK
Single-leaf doors									
750 x 875						●			
800 x 800						●			
875 x 875						●			
875 x 1000						●			
875 x 1250						●			
875 x 2000	●		●						
875 x 2125	●		●						
625 x 2000									●
750 x 1750					●				
750 x 1875					●				●
750 x 2000		●		●	●		●	●	●
750 x 2125		●			●		●	●	●
800 x 1750									
800 x 1800					●				
800 x 1875					●				
800 x 2000					●				
875 x 1750					●				
875 x 1800					●				
875 x 1875		●		●	●		●		●
875 x 2000		●		●	●		●	●	●
875 x 2125		●		●	●		●	●	●
1000 x 1875		●		●			●		●
1000 x 2000	●	●	●	●			●	●	●
1000 x 2125	●	●	●	●			●	●	●
1125 x 2000							●		
1125 x 2125				●			●		
1250 x 2000				●					
1250 x 2125				●					
Double-leaf doors									
1500 x 2000				●			●		●
1500 x 2125							●		
1750 x 2000				●			●		●
1750 x 2125							●		
2000 x 2000				●			●		●
2000 x 2125				●			●		●
2125 x 2125							●		
2250 x 2250							●		

Please state handing on order!



Left-hand hinged



Right-hand hinged

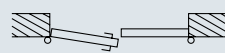

Traffic leaf left-hand hinged



Traffic leaf right-hand hinged

Special sizes	External doors				Internal doors				
Ordering size (nominal size)	Security door		Multi-purpose door		Fire-rated door		Multi-function door	Fire-rated security door	Internal door
	KSI Thermo	KSI	MZ Thermo	MZ	H8-5 door	H8-5 hatch	H3D	WAT	ZK
Single-leaf doors									
Width	875 – 1250	625 – 1250	825 – 1250	625 – 1250	625 – 1000	625 – 1000	625 – 1125	625 – 1164	500 – 1250
Height	1875 – 2250	1700 – 2250	1875 – 2250*	1570 – 2134	1750 – 2125	800 – 1749	1750 – 2250	1964 – 2132	1500 – 2250
Double-leaf doors									
Width				1250 – 2250			1375 – 2250		1500 – 2500
Height				1570 – 2134			1750 – 2250		1500 – 2250

*TPS 021: 1990 – 2250

Frames	Corner frame	Profile frame
Ordering size (nominal size)		
625 × 2000	●	●
750 × 2000	●	●
875 × 2000	●	●
1000 × 2000	●	●
625 × 2125	●	●
750 × 2125	●	●
875 × 2125	●	●
1000 × 2125	●	●

Profile frame	Brickwork	Partition wall	Gypsum plasterboard
Wall widths (MW)			
75		●	
80	●		●
100	●	●	●
125		●	
130	●		
145	●		
150		●	
160	●		
180	●		
205	●		
270	●		
290	●		
330	●		



Experience Hörmann Quality

For every application involving new construction and modernisation

Garage doors

Optimally match your personal architectural style: up-and-over or sectional doors made of steel, GRP or timber.

Door operators

Enjoy extra convenience and break-in-resistant security: Hörmann operators for garage doors and entrance gates.

Entrance doors

Our comprehensive aluminium entrance door ranges include models that fit almost every need and requirement.

Steel doors

Sturdy doors for your entire home, from basement to roof.

Frames

Choose from our comprehensive range of products for new construction, expansion and modernisation.



www.hoermann.com

All rights reserved. No part may be reproduced without our prior permission. Subject to changes.